



2/2-way Solenoid Valve for gases, DVGW approved

- Direct acting solenoid valve
- Switches without differential pressure
- Gauze filter on inlet
- Brass body

Type 0285 can be combined with...



Type 2508

Cable plug



Type 1078

Timer unit
(only for AC version)



Type 2511

ASI cable plug

The direct acting plunger solenoid valve Type 0285 is normally closed by spring force. During switching the core of the seal is tightened against the spring force, and opens the valve. The inlet has a gauze filter fitted. The valve is delivered as standard with a bracket fitment. Type 0285 is best suited to flammable gases.

Circuit function A

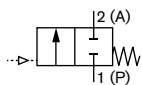

2/2 way valve, operated by external air, normally closed

Technical data	
Orifice	DN 6-12 mm
Body material	Brass
Internal parts of valve	Stainless steel 1.4105, 1.4571
Seal material	NBR, FKM
Media	flammable mediums like energy gas, natural gas, liquid gas, acetylene, hydrogen as NBR, however with more volatile substances, e.g. solvents, hydrosulphide etc.
NBR	
FKM	
Medium temperature	0 to 80 °C
NBR	
FKM	
Ambient temperature	0 to 60 °C
Port connection	Thread R 1/4 and R 1/2 acc. to DIN 2999
Special feature	Gauze filter in inlet
Operating voltage	24 V DC 220-230 V/50 Hz 220-230/UC
Voltage tolerance	±10%
Cycle rate	ca. 1000/min
Duty cycle	100% continuous operation
Electrical connection	Cable plug for cable Ø 7mm (included in delivery)
Protection class	IP 65 with cable plug
DVGW-Approval	Group 2, Class A
Test regulations	DIN EN 161
Installation	As required, preferably with actuator upright
Mounting	with retaining bracket











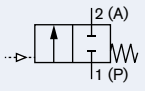





Technical data, *continued*

Orifice [mm]	Port connection acc. to 2999	Kv value water [m ³ /h]	Pressure range		Response times		Power consumption			Weight [kg]
			AC [bar]	DC/UC [bar]	Opening [ms]	Closing [ms]	AC Inrush [VA]	AC Hold [VA/W]	DC [W]	
6	R 1/4, 1/2	0.7	3.5	3.5	10 to 20	20 to 30	30 to 75	16/10	12	0.7
12	R 1/2	1.8	–	0.2						0.7
12	R 1/2	1.8	0.5	–						0.7

Flow rate Kv value water [m ³ /h]	measured at +20°C, 1 bar pressure at valve inlet and free outlet
Pressure values [bar]	gauge pressures with respect to the prevailing atmospheric pressure
Response times [ms] Opening Closing	measured with water at valve outlet at 6 bar and +20°C pressure build-up 0 to 90% pressure decay 100 to 10%

Ordering chart for valves (other versions on request)

All valves with brass body, and with cable plugs. Fitting bracket included in delivery unless otherwise stated.

Circuit function	Orifice [mm]	Port connection DIN 2999	Kv value water [m ³ /h]	Air flow rate at P _{max} [l/min]	Pressure range [bar]	Bemerkung	Seal material	Voltage / Fre- quency [V/Hz]	Item no.	
A 2/2 way valve, operated by external air, normally closed 	6.0	R 1/4	0.7	41	0 - 3.5		NBR	230/50	041910 	
					0 - 3.5			24/DC	047782 	
					0 - 3.5	without fitting bracket		230/50	057044 	
					0 - 3.5			230/50	072896 	
					0 - 3.5			230/UC	043765 	
					0 - 3.5	low-noise		230/UC	088689 	
		12.0	R 1/2	1.8	33	0 - 0.2		FKM	230/50	055012 
						0 - 2.0			230/UC	047750 
						0 - 0.2			24/DC	023552 
						0 - 0.5			230/50	043582 
						0 - 0.5	without fitting bracket		230/50	043757 
						0 - 0.2			230/UC	020807 
	21	R 1/2	1.8	21	0 - 0.2	low-noise	FKM	230/UC	021510 	
					0 - 0.5			230/50	067200 	
					low-noise		230/UC	057691 		

• All universal current with integrated rectifier

Dimensions [mm]

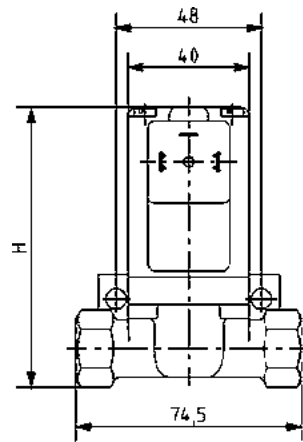

Port connection	H
R 1/4	93
R 1/2	95.5

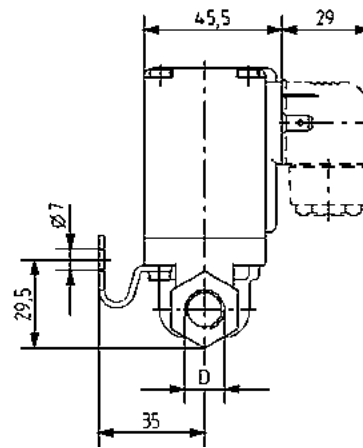

Valve with fitting bracket

To find your nearest Bürkert facility, click on the orange box →

www.burkert.com