

- Electropneumatic positioner for pneumatically actuated process valves
- II (1) 2 G EEx ia IIC T6 approval
- PROFIBUS PA
- HART protocol

Type 8635 can be combined with...

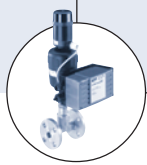

Type 2712

Globe valve

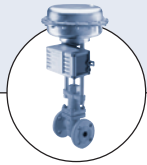

Type 265

Globe valve

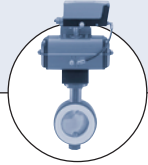

Type 3210

Part-turn actuator

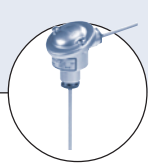

Type ST20

Temperature transmitter

The SideControl Positioner Type 8635 is an electropneumatic positioner for pneumatically actuated process valves with linear or part-turn actuators. It is available in the versions 8635 PA and 8635 S. Both versions are executed in two-conductor technology. With Type 8635 PA, communication and energy supply are via PROFIBUS PA whereas with Type 8635 S, the input signal serves for setpoint transmission and energy supply of the device simultaneously. Alternatively with Type 8635 S, communication may be via HART protocol.

Signal processing, control and actuation of the internal positioning system are accomplished with microprocessor-controlled electronics. The software function Autotune implemented therein enables automatic adaptation of the positioner to the control valve in use.

The positioner is parametrized and operated comfortably via three operating keys and a plain-text display, or with Engineering-Tools via PROFIBUS PA (Type 8635 PA) or optionally via HART protocol (Type 8635 S). It is possible to set up a decentralized control system if a process controller with PID characteristics is used (Type 8635 S).

As an option, the SideControl Positioner Type 8635 can be supplied with approval for use in the Ex area (Zone 1) to ATEX. Because of its compact and robust design, the housing is suitable for use in chemical and process engineering.

Technical data	
Housing material	aluminium, hard anodized and plastic coated
Other external parts	stainless steel V4A
Seal material	NBR, Neoprene
Control medium	Instrument air DIN ISO 8573-1 Class 5 ($\leq 40 \mu\text{m}$ particle size) Class 5 ($\leq 10 \text{ mg/m}^3$) Pressure dew point min. 10° under operating conditions Class 3 ($\leq 1 \text{ mg/m}^3$)
Control air temperature	$-25 \dots +60 \text{ }^\circ\text{C}^{(1)}$
Ambient temperature	$-25 \dots +60 \text{ }^\circ\text{C}^{(1)}$
Supply pressure	$1.4 \dots 6 \text{ bar}^{(3)}$
Air flow capacity²⁾	55 l/min at $1.4 \text{ bar}^{(3)}$ 170 l/min at $6 \text{ bar}^{(3)}$ for pressurizing and venting
Intrinsic air consumption	0 l/min
Positioning range	Linear actuator 3 ... 130 mm Part-turn actuator 0 ... 120°
Position sensor system	high-resolution, conductive plastic, rotary potentiometer
Operation	operating keys and plain-text display
Communication	Type 8635 PA PROFIBUS PA to IEC 1158-2 Profile B for actuators Version 3 Type 8635 S HART communication (optional)
Operating software	Type 8635 PA <ul style="list-style-type: none"> ▪ SIMANTIC PDM ▪ FDT⁴⁾ interface is being prepared for HART communication ▪ others on request
Electrical connection	2xM20x1.5 bushing clamping range 6 ... 12 mm screw terminals for $0.14 \dots 1.5 \text{ mm}^2$

Technical data (continued)

Technical data	
Electrical data Type 8635 PA	
Operating voltage to Ex segment coupler to segment coupler	9 ... 15 V DC (Ex)
Operating current	9 ... 24 V DC (non-Ex)
Fault current protection	12 mA without FDE, from bus 5 mA (FDE)
Electrical data Type 8635 S	
Current supply for electronics	via setpoint signal 4 ... 20 mA
Burden voltage	< 10.2 V DC
Setpoint setting	4 ... 20 mA or HART

Technical data	
Control air sockets	G 1/4 NPT 1/4; RC 1/4 on request
Mounting kits for linear actuator for part-turn actuator	to Namur recommendation to DIN IEC 534 T6 to VDI/VDE 3845
Mass	ca. 1.5 kg
Type of protection	IP65 to EN 60529
Type of ignition protection	II (1) 2G EEx ia IIC T6 to DIN EN 50020
Certification	
Type 8635 PA	to ATEX 2038 (PTB03)
Type 8635 S	to ATEX 2027 (PTB04)
Conformity	▪ EMC-89/336/EEC

¹⁾ Up to +65 °C temperature class T4/T5 or without EEx i approval.

²⁾ May be adapted to actuator size with throttle screw.

³⁾ Pressure data in bar; overpressure to ambient.

⁴⁾ FDT: Field Device Tool

Other electrical data

	Function values	Permissible maxima as per Certificate of Conformity				
		8635 PA	8635 S		8635 PA	8635 S
Power Supply	U	9 ... 15 V	10.2 V	Ui	15 V	30 V
	I	12 mA bus-supplied	4 mA	li	215 mA	100 mA
Process value input (only for version with process controller)	Burden	-	10 Ω	Pi	1.95 W	1 W
	Burden voltage U	-	< 200 mV	Uo	-	30 V
				lo	-	100 mA
				Po	-	1 W
Binary input	make/break contact (conf.)	-	-	Co	40 μF	5.5 μF
				Lo	1000 mH	1000 mH
Analog feedback (option)	U	-	12 ... 30 V	Uo	-	30 V
	I	-	4 ... 20 mA	lo	-	100 mA
Limit switches (option) (NAMUR initiators)	U	8 V	8 V	Po	-	1 W
	I uncoated	3 mA	3 mA	Uo	15.5 V	15.5 V
	I coated	1 mA	1 mA	lo	52 mA	52 mA
				Po	150 mA	150 mA

Type 8635 S: Recommendations for isolation transformers / DC transformers Input 4 ... 20 mA / output 4 ... 20 mA

Company	Model	Burden	HART	EX	active/passive
Pepperl+Fuchs	KFD2-CD-Ex1.32	850 Ω	-	x	A
Foxboro Eckardt	TV228-S-EGX	700 Ω	x	x	A
Foxboro Eckardt	MT228-S-EGX	750 Ω	-	x	A
Foxboro Eckardt	II949-S1 ZZZ	750 Ω	-	-	A
Stahl	9318/16-22-10	700 Ω	x	x	A
Stahl	M318/12-11-00	1000 Ω	-	x	A
PhoenixContact	PI/EX-ID-I/I	800 Ω	-	x	A

- Data given without guarantee of accuracy.
- For dimensioning and operation of intrinsically safe circuits, the user/owner is responsible.

Software functions (depending on the device configuration chosen)

Type 8635 PA / Type 8635 S

- Automatic commissioning of control system
- Parametrization of the positioner
- Automatic or manual entry of characteristic curve for correction of operating characteristic
- Setting of the tight-closure or maximum stroke threshold
- Stroke limitation
- Limitation of positioning speed
- Dead band
- Direction of action of the controller setpoint
- Signal range splitting (split range up to 4 times)
- Setting of direction of movement
- Definition of a safety position
- Calibration of input and display
- Configuration of binary input
- Code protection for settings/operation
- RESET of factory settings

Technical data (continued)

Software functions (depending on the device configuration chosen)

Other software functions on Type 8635 S

- Optional built-in process controller (PID)
- Automatic parametrization of the process controller
- Setting of the parameters of the process controller
- Calibration of the setpoint input and display
- Configuration of the analog input
- Configuration of the binary input and binary outputs

Dimensions [mm]

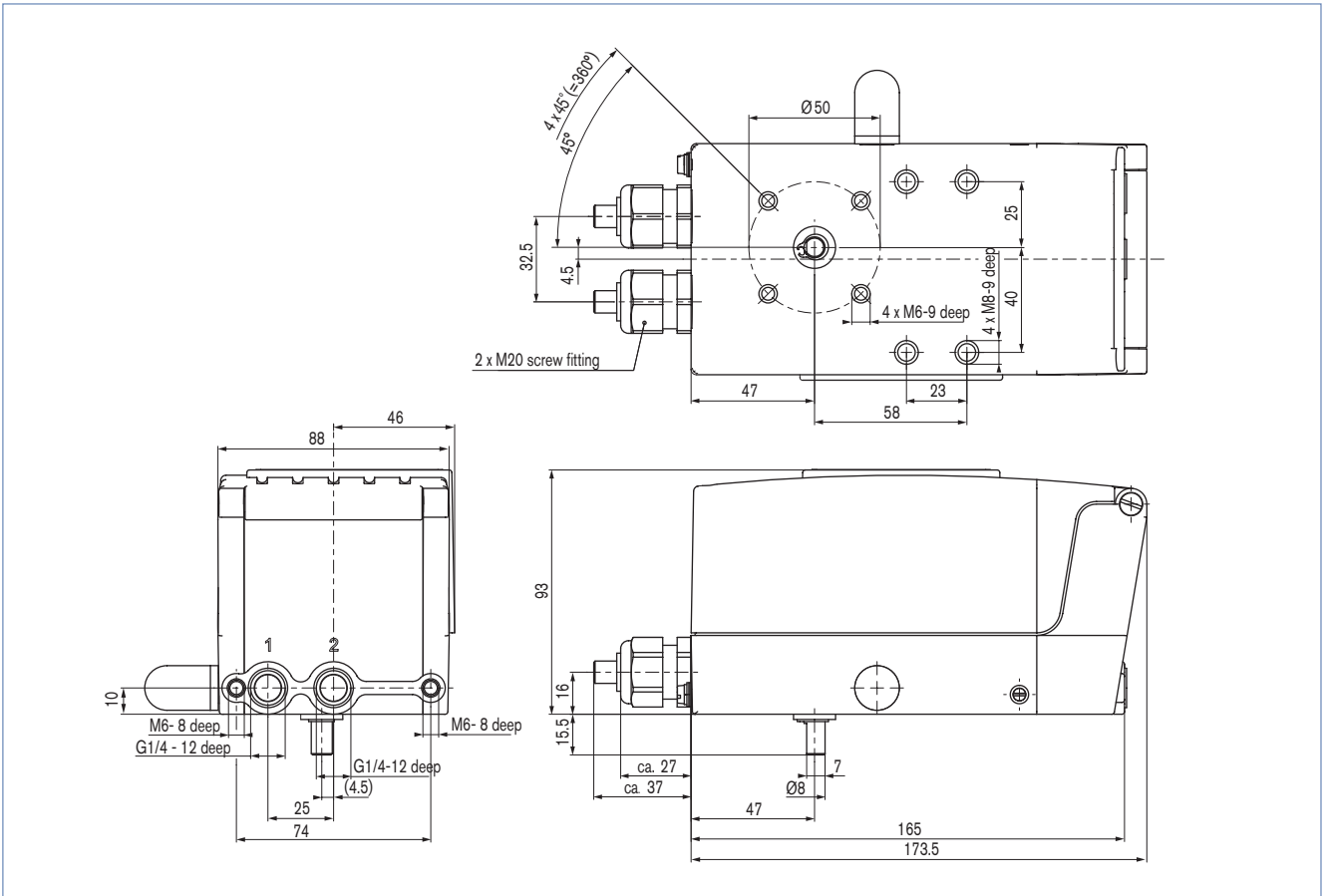

Interfaces

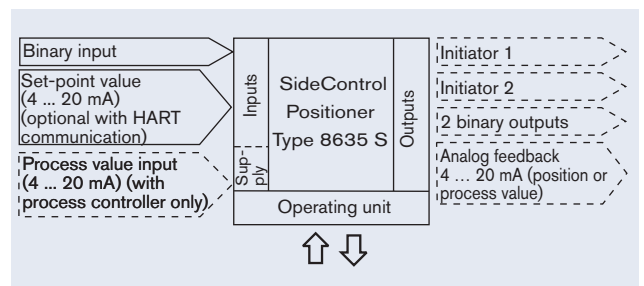
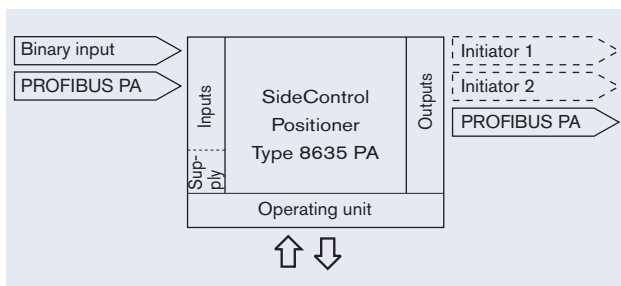

Note
The optional inputs and outputs are shown by dotted lines.

Ordering chart (excerpt, other versions on request)

Type 8635 PA

Function ¹⁾	Initiator DIN EN 60947-5-6	Position sensor system	Mounting on pneu- matic linear or part-turn actuator	EEx approval (to ATEX)	Item no.
Pos.	none	internal	to NAMUR ²⁾	EEx ia II C T6	147 275
Pos.	2 open/close	internal	to NAMUR ²⁾	EEx ia II C T6	160 543
Pos.	none	internal	to NAMUR ²⁾	none	155 368
Pos.		external	mounting on control valve type 27XX	EEx ia II C T6	153 045
Pos.		external	mounting on control valve type 27XX	none	155 367

¹⁾ Pos.: positioner
²⁾ DIN/IEC
534-6;
VDI/VDE 3845

Type 8635 PA is designed for attachment to single-acting actuators.

Other options

- External position sensor system
- Universal integrated attachment (air channelling without piping)
- Manometer block VA (inlet air and actuator chamber)
- Initiators to NAMUR as limit switches (optional)

Type 8635 S

Function ¹⁾	Position sensor system	Communi- cation	Initiator DIN EN 60947-5-6	Analog feedback incl. 2 binary outputs	Mounting on pneu-matic linear or part-turn actuator	EEx approval (to ATEX)	Item no.
Pos.	external	none		no	mounting on control valve type 27XX	EEx ia II C T6	150 347
Pos.	external	HART		no	mounting on control valve type 27XX	EEx ia II C T6	151 681
Pos.	external	none		yes	mounting on control valve type 27XX	EEx ia II C T6	155 369
Pos.	external	HART		yes	mounting on control valve type 27XX	EEx ia II C T6	155 370
Pos.	internal	none		no	NAMUR (DIN IEC 534-6; VDI/VDE 3845)	EEx ia II C T6	147 263
Pos.	internal	none	2 open/close	no	NAMUR (DIN IEC 534-6; VDI/VDE 3845)	EEx ia II C T6	160 542
Pos.	internal	HART		no	NAMUR (DIN IEC 534-6; VDI/VDE 3845)	EEx ia II C T6	147 269
Pos.	internal	none		yes	NAMUR (DIN IEC 534-6; VDI/VDE 3845)	EEx ia II C T6	155 371
Pos.	internal	HART		yes	NAMUR (DIN IEC 534-6; VDI/VDE 3845)	EEx ia II C T6	155 372
Pos.	internal	none	2 open/close	yes	NAMUR (DIN IEC 534-6; VDI/VDE 3845)	none	160 667
Pos.+pro	external	none		no	mounting on control valve type 27XX	EEx ia II C T6	151 111
Pos.+pro	external	HART		no	mounting on control valve type 27XX	EEx ia II C T6	151 682
Pos.+pro	external	none		yes	mounting on control valve type 27XX	EEx ia II C T6	155 373
Pos.+pro	external	HART		yes	mounting on control valve type 27XX	EEx ia II C T6	155 374
Pos.+pro	internal	none		no	NAMUR (DIN IEC 534-6; VDI/VDE 3845)	EEx ia II C T6	147 264
Pos.+pro	internal	HART		no	NAMUR (DIN IEC 534-6; VDI/VDE 3845)	EEx ia II C T6	147 270
Pos.+pro	internal	none		yes	NAMUR (DIN IEC 534-6; VDI/VDE 3845)	EEx ia II C T6	155 375
Pos.+pro	internal	HART		yes	NAMUR (DIN IEC 534-6; VDI/VDE 3845)	EEx ia II C T6	155 376
Pos.	internal	none		no	NAMUR (DIN IEC 534-6; VDI/VDE 3845)	none	147 265
Pos.	external	none		no	mounting on control valve type 27XX	none	147 267
Pos.+pro	internal	none		no	NAMUR (DIN IEC 534-6; VDI/VDE 3845)	none	147 266
Pos.+pro	external	none		no	mounting on control valve type 27XX	none	147 268

¹⁾ Pos.: positioner; pro: process controller

Type 8635 S is designed for attachment to single-acting actuators.

Other options

- Universal integrated attachment (air channelling without piping)
- Manometer block VA (inlet air and actuator chamber)
- Initiators to NAMUR as limit switches (optional)

Ordering chart for accessories

Version	Item no.
Mounting kit for linear actuators to DIN IEC 534-6	787 215
Mounting kit for part turn actuators to VDI/VDE 3845, without bracket	787 338
Manometer block with 2 manometers, VA	654 602
Attachment kit for piston actuators type 27XX, 80 mm	651 771
Attachment kit for piston actuators type 27XX, 100 mm/125 mm	651 772
Attachment kit for piston actuators type 27XX, 175 mm/225 mm	655 567
Position sensor system for piston actuators type 27XX, 80 mm	651 751
Position sensor system for piston actuators type 27XX, 100 mm/125 mm	653 021
Position sensor system for piston actuators type 27XX, 175 mm/225 mm	655 535

Ordering note

When attached to a Burkert control valve, the SideControl positioner type 8635 PA/S will be supplied only as part of a complete control valve (positioner, position sensor system, associated attached parts and control valve).

- To select a suitable control valve, use the data sheets of types 27XX.
To order a complete control valve, state the following numbers:
the order no. of the SideControl positioner type 8635 PA/S
the order no. of the position sensor system,
the order no. of the selected control valve and
the order no. of the associated attached parts with the remark
SideControl positioner type 8635 PA/S control valve.
- Burkert supplies a completely assembled and tested control valve.

To find your nearest Burkert facility, click on the orange box →

www.burkert.com

If case of special conditions,
please consult for advice.

We reserve the right to make
technical changes without notice.

0603/02_EU-EN_00891939